

Platter Turning Instructions

by Dale L. Nish

Platters are a very useful woodturning project. They are typically turned from wood 1 1/2 to 2 inches thick and are usually 12 to 16 inches diameter. Typical uses are for serving crackers, cookies, etc. These instructions are for use with a screw center faceplate, but a regular faceplate screwed to the top of the platter would work just as well.

STEP 1

- a) Drill a 1/4" hole 3/4" deep for a platter 1 3/4 - 2" thick.

5/8" deep for a platter 1 1/2" thick and use a 1/8" thick shim washer between the faceplate and the wooden disc.

- b) Install the screw center faceplate onto the lathe, and screw the platter onto the screw.

The platter should be firm against the faceplate. For increased safety and to decrease possible vibration, I suggest moving the tailstock and revolving center into position to support the platter while turning up the edge and roughing out the back of the platter.

- c) For a 12 to 14 inch platter, set the lathe speed at around 500 rpm.

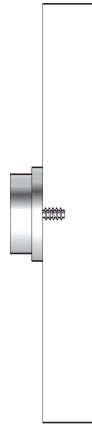

STEP 2

- a) True up the edge of the platter.

- b) Face off the bottom of the platter.

- c) Layout the dovetail recess which will receive the chuck jaws in the expansion mode.

The recess is 3 1/2 - 4" diameter and 1/4" deep.

- d) Remove the waste wood from the dovetail recess with a small gouge.

- e) Clean up the corners and cut the 5 degree dovetail angle.

Use a skew chisel flat on the tool rest and used as a scraper, long point cutting and forming the dovetail.

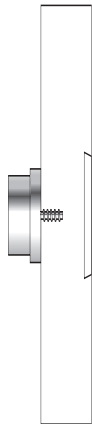

STEP 3

- a) Turn a foot ring around the recess area.

The diameter of the foot ring should be about 1/2 the diameter of the platter.

- b) Turn the platter to rough shape.

- c) True up both sides of the outside rim of the platter.

This will tell you how much thickness you have to work with before you turn the rim to final shape and thickness.

- d) Complete the outside shape of the platter.

- e) Design the rim so it feels comfortable in your hand.

- f) Sand and finish the outside of the platter, including the recess.

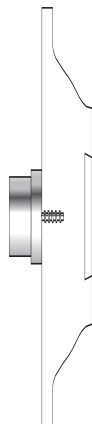

STEP 4

- a) Remove the platter from the screw center faceplate.

- b) Install the expanding chuck on the lathe.

- c) Fit the platter to the expanding chuck. Tighten securely.

- d) Move the tailstock with the revolving center into the support position.

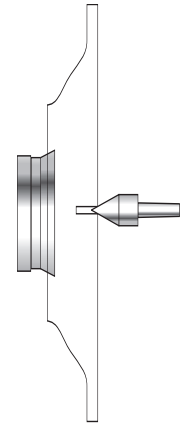

STEP 5

- a) Turn the inside of the platter with a 1/2" bowl gouge.

Shape the rim area as desired.

Remove most of the material down to the center, then move the revolving center and remove the rest of the wood.

- b) Turn a gentle, pleasing curve from the rim to the bottom of the platter.

The bottom should be flat or have a shallow concave curve.

- c) Measure carefully for depth.

Leave 1/4" or more wood above the dovetail recess.

The most common error in turning a platter is to get the bottom area over the dovetail recess too thin!



STEP 6

- a) Sand and finish the inside of the platter.

SANDING

I prefer the Velcro sanding system, as it works well on gentle curves and seldom leaves friction or burn marks. The 2" pads work well on the outside of the platter, due to tight curves. The 3" pads work best on the inside of the platter, with the larger pad area making it easier to keep large areas flat and smooth. I suggest a sanding sequence of 80 grit, 100, 150, 220 and 320. Some hand sanding may be necessary to remove minor cross grain scratches. The coarse grit you start sanding with should be used to remove all tooling marks, tear out, irregular surfaces, etc, before continuing to the sequence of fine grits.

FINISHING

I prefer finishing the platter with a full wet coat of lacquer sanding sealer, brushed on. This will seal the end grain and uniform the porosity of the wood, making it easier to use an oil finish later. Without sealing, the oil will tend to penetrate deep into some areas and turn light wood yellow and dark woods splotchy.

Let the full wet coat of lacquer stay on the wood for a minute or two, then wipe dry with cloth or rag. When the wet lacquer has been removed, turn the lathe on and spin the platter against a clean rag or cloth until all the lacquer has been removed from the surface and the surface feels dry. If the surface has any dust or finish left on it, remove it with a light touch of 0000 steel wool.

The platter is now ready for a coat of Danish oil. I prefer Waterlox, which seems to give a satin sheen finish with only 2 or 3 coats. Apply a coat of oil, let it set for 3 to 5 minutes, then wipe it dry. Let the platter dry for 24 hours, then apply another coat and repeat the procedure. Each coat will increase the thickness of the oil film; gradually building to the finish you want. It may be necessary to re-coat the piece after a period of time to restore luster and sheen, but additional coats of oil will make the platter look better and better.

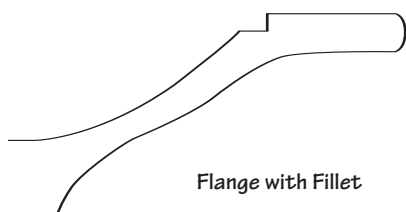
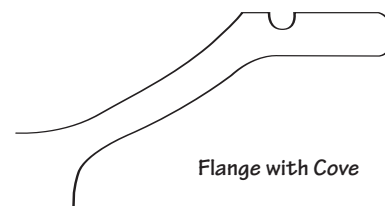
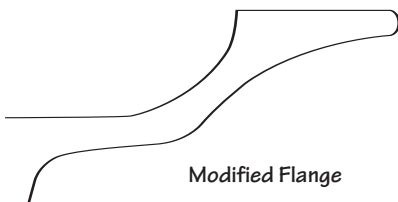
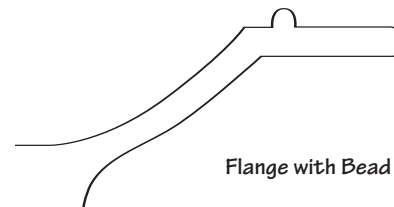
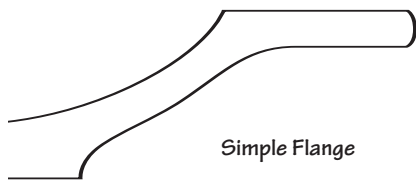
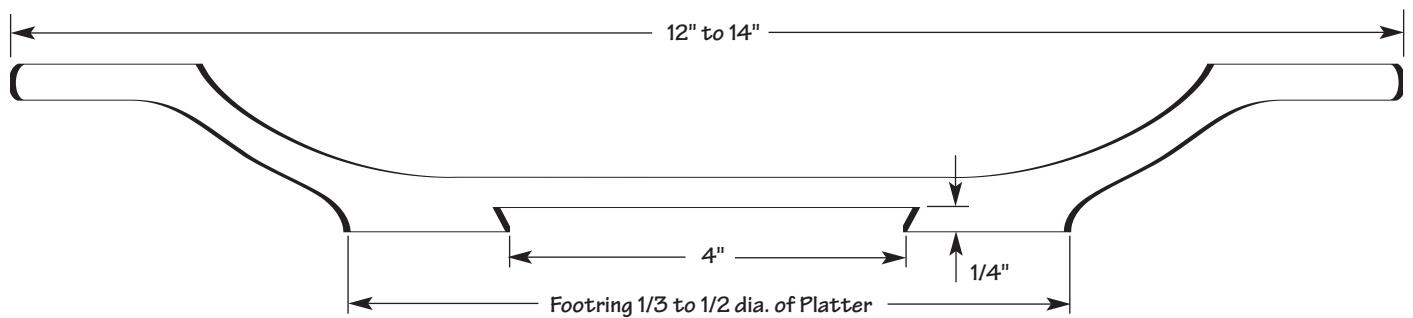

Adapted from
The Woodturners' Notebook
by Ray Key